

JHA0035SR 90° DATASHEET

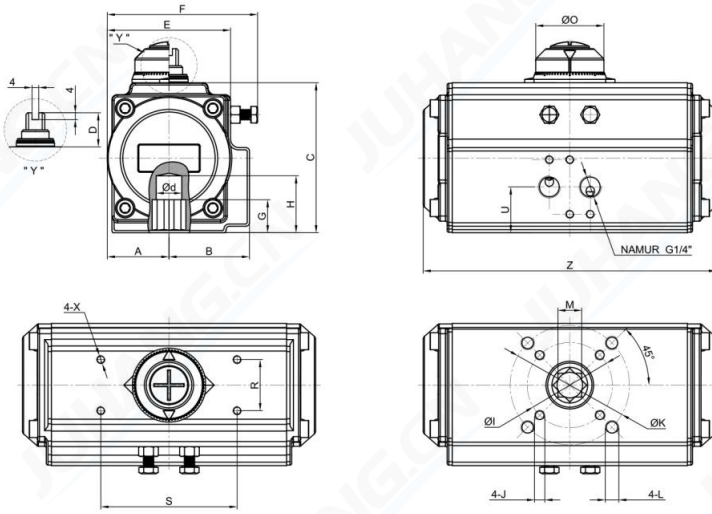

Reference Parameters			
Cylinder size	63		mm
Weight	2.3		kg
Air volume	Open	0.21	L
	Close	-	
Cycle speed*①	Open	<1	s
	Close	<1	
Pressure rang	2 up to 8		bar(g)
Media	Clean,dry and non-corrosive compressed air		
Temperature	High	-15 up to 150	°C
	Standard	-20 up to 80	
	Low	-40 up to 80	
Flange	F03&F05		
Stroke	90±5		°

> According to EN 15714-3 & ISO 5211

>*①. Test conditions: clean air with a pressure of 6 bar,the diameter of the pipe is 8 mm,and the temperature is room temperature.

Dimensions in mm

Model	A	B	C	D	E	F	G	H	φI	J	φK	L	M	R	S	X	O	U	φd	Z	Air connection
JHA0035SR	36	47	88	20	72	88	19	33	50	M6*10	70	M8*13	14	30	80	M5*8	40	27	15	172	G1/4"

OUTPUT TORQUE (Unit:N.m)

Model	Air Supply Pressure in bar(g)																				
	Spring Type	2.5		3		4		4.5		5		5.5		6		7		8		Spring output	
		0°	90°	0°	90°	0°	90°	0°	90°	0°	90°	0°	90°	0°	90°	0°	90°	0°	90°	Start	End
JHA0035SR	K6	9.6	5.1	13.1	8.6	20.2	15.7	23.8	19.2	27.3	22.8									12.7	8.2
	K8			10.4	4.4	17.5	11.5	21.0	15.0	24.6	18.6	28.2	22.2	31.7	25.7	38.8	32.8			16.9	11.0
	K10					14.7	7.3	18.3	10.8	21.9	14.4	25.4	17.9	29.0	21.5	36.1	28.6	43.2	35.7	21.2	13.7
	K12									19.1	10.1	22.7	13.7	26.2	17.3	33.3	24.4	40.5	31.5	25.4	16.4

OUTPUT TORQUE (Unit:lbf.in)

Model	Air Supply Pressure in psi																				
	Spring Type	36		44		58		65		73		80		87		102		116		Spring output	
		0°	90°	0°	90°	0°	90°	0°	90°	0°	90°	0°	90°	0°	90°	0°	90°	0°	90°	Start	End
JHA0035SR	K6	85	45	116	76	179	139	211	170	242	202									112	73
	K8			92	39	155	102	186	133	218	165	250	196	281	227	343	290			150	97
	K10					130	65	162	96	194	127	225	158	257	190	320	253	382	316	188	121
	K12									169	89	201	121	232	153	295	216	358	279	225	145

Notes:

> 1 bar(g) = 14.5038 psi ; 1 N.m = 8.8507 lbf.in

> For further information regarding options , materials , certifications and additional execution please contact JUHANG's sales office.

> Flange and bi-square drive shall comply with ISO 5211 standard.

> Solenoid valve mounting interface according to VDI/VDE 3845(NAMUR)

